



**HIGH-WALL DUCTLESS
AIR CONDITIONING & HEATING SYSTEM
OWNER'S MANUAL**

Models:

LIVV09HP230V1A
LIVV18HP230V1A
LIVV30HP230V1A

LIVV12HP230V1A
LIVV24HP230V1A
LIVV36HP230V1A



Thank you for choosing a Livv Heat Pump System!

You can feel confident in your selection because the same pride in craftsmanship and engineering knowledge that goes into millions of other Gree installed products worldwide has gone into your unit.

Please read this owner's manual carefully before operation and retain it for future reference.

Table of Contents

<i>Introduction</i>	<i>2</i>
<i>Nomenclature</i>	<i>2</i>
<i>Safety Precautions</i>	<i>3-4</i>
<i>Part Names</i>	<i>5</i>
<i>System Functions</i>	<i>6-8</i>
<i>Operation of Wireless Remote Controller</i>	<i>9-16</i>
<i>Damaged or Lost Remote Controller</i>	<i>17</i>
<i>Care and Cleaning</i>	<i>18</i>
<i>Troubleshooting</i>	<i>19 - 20</i>
<i>Energy Saving Tips</i>	<i>21</i>
<i>Warranty</i>	<i>Back</i>

INTRODUCTION

Superior Design for Superior Performance

Gree's Livv Inverter-driven, Mini Split Heat Pumps are beautifully designed to deliver effective cooling or heating, while fitting unobtrusively into any decor. The indoor unit's aesthetically pleasing, minimalist design blends nicely in any home or office.

Your Livv unit offers quiet, energy-efficient comfort, powered by Gree's famous G10 Inverter technology. To speed the process of bringing conditioned air exactly where you want it, the unit features both horizontal and vertical air flow control. Customizable mode controls allow you to adjust fan speeds, select sleep-time settings and more, all through the easy-to-use wireless remote controller, or an optional Wired Tether Controller.

There's even a Turbo, Power Failure Memory and other advanced features to make the Livv system even more versatile, for year-round comfort and energy savings.

NOMENCLATURE

Example: LIVV24HP230V1AH

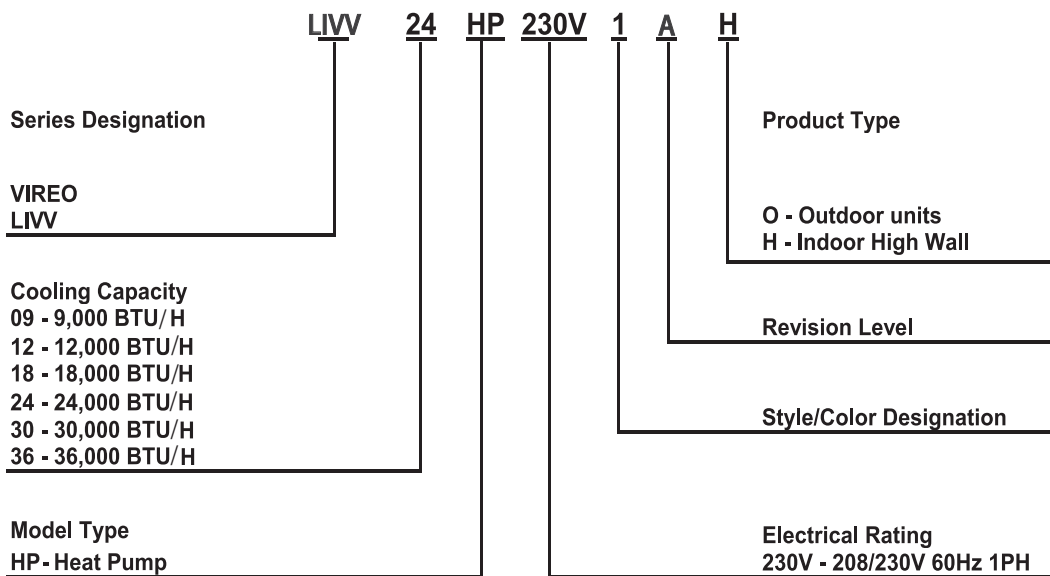

SAFETY PRECAUTIONS

Please read the following before operation.

Recognize safety information.  This is the safety-alert symbol. When you see this symbol on the unit and in instructions or manuals, be alert to the potential for personal injury. Understand these signal words: **DANGER**, **WARNING**, and **CAUTION**. These words are used with the safety-alert symbol.

DANGER identifies the most serious hazards which will result in severe personal injury or death.

WARNING signifies hazards which could result in personal injury or death.

CAUTION is used to identify unsafe practices which may result in minor personal injury or product and property damage.

NOTE is used to highlight suggestions which will result in enhanced installation, reliability, or operation.

NOTE: Your actual air conditioning & heating system and related devices may differ from the images shown in this manual.

WARNING

This appliance is not intended for use by children without responsible adult supervision. Proper care should be taken to ensure safety.

WARNING

Heat pumps, air conditioners & heating equipment should be installed, started up, and serviced only by qualified installers and service technicians. Air conditioning, heat pumps and refrigeration systems are hazardous due to high voltage electrical components, high refrigerant pressures, and moving parts.

WARNING

- Disconnect electrical power to the indoor and outdoor units before performing any maintenance or cleaning.
- Do not attempt to repair the Gree system yourself. Incorrect repairs may cause electric shock or fire. Contact a qualified service technician for all service requirements.
- Keep combustible materials away from the unit.

SAFETY PRECAUTIONS

Please read the following before operation.

CAUTION

- Do not put hands or any objects into the air inlets or outlets. This may cause personal injury or damage the unit.
- When cleaning, be careful not to splash water on the unit. Doing this may cause electric shock or damage to unit.
- Do not use or place any flammable, combustible or noxious substance next to the unit.
- In the event of a failure (burning smell, etc.), immediately disconnect all electrical power to indoor and outdoor units.
- Never try repairing the system yourself; contact a qualified service technician for all repairs.

Icons Displayed

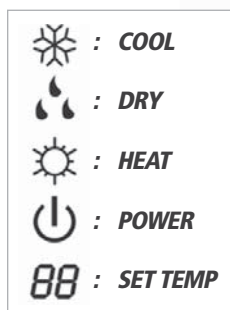

Front Panel Display

The front panel on the Livv indoor unit contains system status lights and easy-to-read LED display.

NOTE: The indoor unit display panel can be turned ON or OFF via the LIGHT button on the remote controller. See "LIGHT" button description for more detail.

PART NAMES

Indoor unit

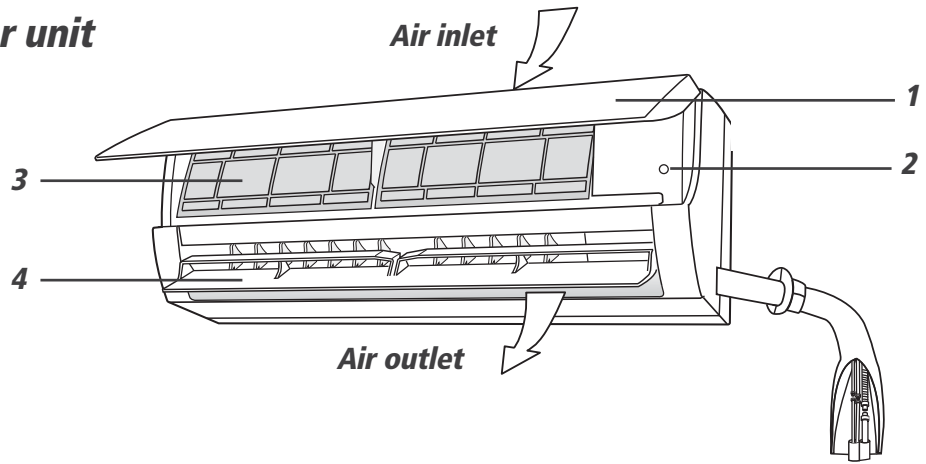

Part Name

1. Front Panel
2. Aux. Button
3. Air Filter
4. Horizontal Louver
5. Remote Controller
6. XE71-44/G Wired Tether Controller (sold separately)
7. Inter-Connection Wire (sold separately)
8. Drain Hose (sold separately)
9. Refrigerant Lines (sold separately)



Outdoor unit

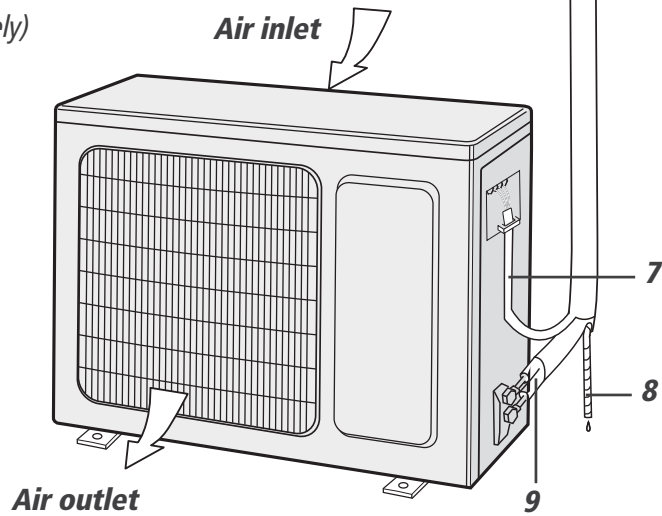

SYSTEM FUNCTIONS

WHISPER QUIET

Not only are the Gree systems energy efficient but they are quiet too. Livv High-Wall units operate with sound pressure levels starting as low as 26 dB(A).

MULTI FAN SPEEDS

Whether operating in either Cooling or Heating mode, the indoor fan can be set to your choice of four different speeds (Low, Medium, High or Turbo) to achieve maximum comfort.

INTELLIGENT PRE-HEATING

The Livv system guards against the annoying cool air blown into the room in heating mode. The system constantly monitors the discharge air temperature. It will delay the indoor fan until the indoor coil has warmed up to prevent blowing uncomfortable cool air into the room.

I FEEL MODE

The unit will sense room temperature at the remote controller instead of at the indoor unit during cooling mode. It then adjusts airflow and temperature accordingly for the ultimate in personal comfort control and energy savings.

ADJUSTABLE AIRFLOW

The Livv system has a bi-directional airflow control for maximum comfort. The indoor unit has adjustable vertical swing louvers and can be set in multiple discharge directions from the wireless remote controller.

TURBO MODE

Use Turbo Mode for situations where you wish to achieve the desired room temperature in the shortest possible time. This mode runs the unit at ultra high speeds for quickest results.

FREEZE GUARD

Room Freeze Guard protection will automatically keep the room temperature from getting too cold, where water pipes might freeze

TIMER MODE

The unit can be programmed to turn ON or OFF after a specific amount of time. The time period is adjustable between one half and 24 hours.

SYSTEM FUNCTIONS

MODE BUTTON

The unit can be set to five different operating modes: HEAT, COOL, DRY, FAN ONLY and AUTO.

NOTE: AUTO MODE has fixed setpoints of 68° F heating and 77° F cooling, which are not adjustable. The system will automatically select heating or cooling to maintain room temperature within this band.

SLEEP MODE

The Livv offers a Sleep Mode function for your comfort. The unit will automatically adjust room temperature during your sleep time. This slight change in temperature will not affect your comfort level due to the natural effects that sleeping has on the body, but it will save on energy consumption and will lower electric bills.

ENERGY SAVINGS MODE

This feature will automatically select the optimal compressor and fan speeds to allow for energy savings while operating in Cooling or Heating modes. The compressor and fan will automatically slow down as the room temperature reaches the set point.

SELF-DIAGNOSIS

Livv has a built-in computer which uses real-time diagnostics which help prolong the unit's life. The automatic diagnosis feature continuously scans for errors or malfunctions and fault codes are shown on the unit display to facilitate troubleshooting and repair.

POWER FAILURE MODE

Power interruptions are no problem for the Livv system. User selections and system parameters are stored in non-volatile memory. These parameters are retained during a power failure. When power is returned, the Livv system will automatically return to the last operating mode.

INTELLIGENT DEFROST

The Livv Intelligent Defrost function increases room comfort and saves energy by eliminating unnecessary defrost cycles. In heating mode, the unit will monitor the outdoor coil for frost build up. Once frost buildup has been detected, the system will switch into a defrost mode to remove the frost.

SYSTEM FUNCTIONS

POLYMERIC AIR FILTER

The polymeric mesh filters save energy by preventing the indoor coils from being plugged with dirt and lint. This economical and sturdy filter may be washed, vacuumed and reused.

FAHRENHEIT °F / CELSIUS °C

The remote controller and indoor wall unit front panel can be set to display in either °F or °C.

PRIVACY LOCK MODE

The wireless remote controller has a Lock feature. The Lock averts unauthorized access or tampering with system settings.

AGENCY LISTINGS

All systems are listed with AHRI (Air conditioning, Heating, and Refrigeration Institute) and are ETL certified per UL Standards.

OPERATION OF WIRELESS REMOTE CONTROLLER

Remote Controller



- ① ON/OFF button
- ② MODE button
- ③ FAN button
- ④ SWING button
- ⑤ TURBO button
- ⑥ ▲ / ▼ button
- ⑦ SLEEP button
- ⑧ TEMP button
- ⑨ WiFi button
- ⑩ LIGHT button
- ⑪ CLOCK button
- ⑫ TIMER ON / TIMER OFF button

Introduction for icons on display screen

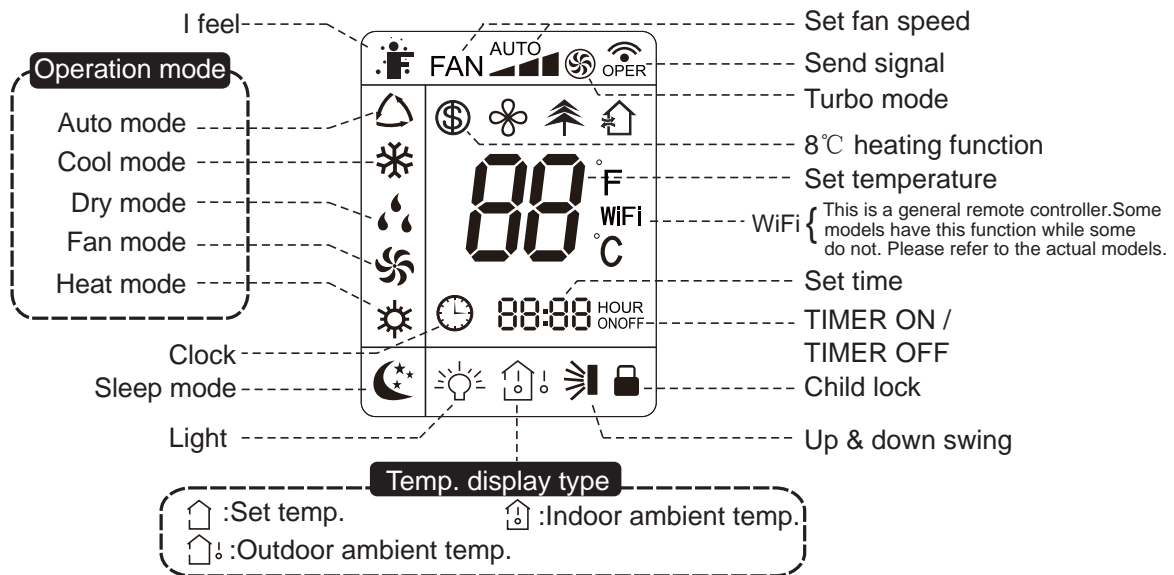

OPERATION OF WIRELESS REMOTE CONTROLLER

Note:

- This is a general use remote controller, it could be used for the air conditioners with multifunction; For some function, which the model doesn't have, if press the corresponding button on the remote controller that the unit will keep the original running status.
- After putting through the power, the air conditioner will give out a sound. Operation indicator is ON (red indicator, the colour is different for different models). After that, you can operate the air conditioner by using remote controller.
- Under on status, pressing the button on the remote controller, the signal icon "📶" on the display of remote controller will blink once and the air conditioner will give out a "di" sound, which means the signal has been sent to the air conditioner.
- Under off status, set temperature and clock icon will be displayed on the display of remote controller (If timer on, timer off and light functions are set, the corresponding icons will be displayed on the display of remote controller at the same time); Under on status, the display will show the corresponding set function icons.
- As for the models with functions of WiFi or wired controller, the indoor unit must has been controlled by standard remote controller under auto mode first, and then the function of adjustable temperature under auto mode can be realized by APP or the wired controller.
- This remote controller can adjust the temperature under auto mode. When matching with the unit which is without the function of adjustable temperature under auto mode, the set temperature under auto mode may be invalid, or the displayed set temperature on the unit is not same as that on the remote controller under auto mode.

1 ON/OFF button

Press this button to turn on the unit. Press this button again to turn off the unit.

2 MODE button

Press this button to select your required operation mode.



- When selecting auto mode, air conditioner will operate automatically according to ex-factory setting. Under auto mode, temperature can be displayed. Under auto mode, set temperature can be adjusted. Press "FAN" button can adjust fan speed. Press "SWING" button can adjust fan blowing angle.
- After selecting cool mode, air conditioner will operate under cool mode. Cool indicator on indoor unit is ON(This indicator is not available for some models). Press "▲" or "▼" button to adjust set temperature. Press "FAN" button to adjust fan speed. Press "SWING" button to adjust fan blowing angle.
- When selecting dry mode, the air conditioner operates at low speed under dry mode. Dry indicator on indoor unit is ON(This indicator is not available for some models). Under dry mode, fan speed can't be adjusted. Press "SWING" button to adjust fan blowing angle.

OPERATION OF WIRELESS REMOTE CONTROLLER

- When selecting fan mode, the air conditioner will only blow fan, no cooling and no heating. Press "FAN" button to adjust fan speed. Press "SWING" button to adjust fan blowing angle.
- When selecting heating mode, the air conditioner operates under heat mode. Heat indicator on indoor unit is ON(This indicator is not available for some models). Press "▲" or "▼" button to adjust set temperature. Press "FAN" button to adjust fan speed. Press "SWING" button to adjust fan blowing angle. (Cooling only unit won't receive heating mode signal. If setting heat mode with remote controller, press ON/OFF button can't start up the unit).

Note:

- For preventing cold air, after starting up heating mode, indoor unit will delay 1~5 minutes to blow air (actual delay time is depend on indoor ambient temperature).
- Set temperature range from remote controller: 16~30°C (61~86°F); Fan speed: auto, low speed, medium speed, high speed.
- Under auto mode, temperature can be displayed; Under auto mode, set temperature can be adjusted.

3 FAN button

Pressing this button can set fan speed circularly as: auto (AUTO), low(▲), medium (▲▲), high(▲▲▲).

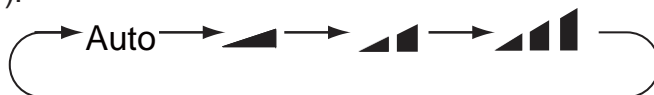

Note:

- Under AUTO speed, air conditioner will select proper fan speed automatically according to ex-factory setting.
- Fan speed under dry mode is low speed.
- X-FAN function: Hold fan speed button for 2s in COOL or DRY mode, the icon “☼” is displayed and the indoor fan will continue operation for a few minutes in order to dry the indoor unit even though you have turned off the unit. After energization, X-FAN OFF is defaulted. X-FAN is not available in AUTO, FAN or HEAT mode.

This function indicates that moisture on evaporator of indoor unit will be blowed after the unit is stopped to avoid mould.

- Having set X-FAN function on: After turning off the unit by pressing ON/OFF button indoor fan will continue running for a few minutes. at low speed. In this period, Hold fan speed button for 2s to stop indoor fan directly.
- Having set X-FAN function off: After turning off the unit by pressing ON/OFF button, the complete unit will be off directly.

4 SWING button

Press this button can select up&down swing angle. Fan blow angle can be selected circularly as below:

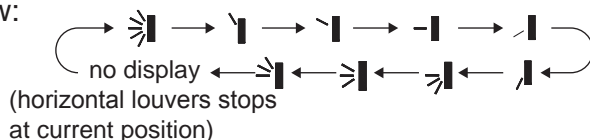

OPERATION OF WIRELESS REMOTE CONTROLLER

- When selecting "↻", air conditioner is blowing fan automatically. Horizontal louver will automatically swing up & down at maximum angle.
- When selecting "↘, ↙, ↗, ↕", air conditioner is blowing fan at fixed position. Horizontal louver will stop at the fixed position.
- When selecting "↗, ↘, ↙", air conditioner is blowing fan at fixed angle. Horizontal louver will send air at the fixed angle.
- Hold "↻" button above 2s to set your required swing angle. When reaching your required angle, release the button.

Note:

"↗, ↘, ↙" may not be available. When air conditioner receives this signal, the air conditioner will blow fan automatically.

5 TURBO button

Under COOL or HEAT mode, press this button to turn to quick COOL or quick HEAT mode. "⚡" icon is displayed on remote controller. Press this button again to exit turbo function and "⚡" icon will disappear.

6 ▲ / ▼ button

- Press "▲" or "▼" button once increase or decrease set temperature 1°C (1°F). Holding "▲" or "▼" button, 2s later, set temperature on remote controller will change quickly. On releasing button after setting is finished, temperature indicator on indoor unit will change accordingly.
- When setting TIMER ON, TIMER OFF or CLOCK, press "▲" or "▼" button to adjust time. (Refer to CLOCK, TIMER ON, TIMER OFF buttons)

7 SLEEP button

Under COOL or HEAT mode, press this button to start up sleep function.



"🌙" icon is displayed on remote controller. Press this button again to cancel sleep function and "🌙" icon will disappear.

8 TEMP button

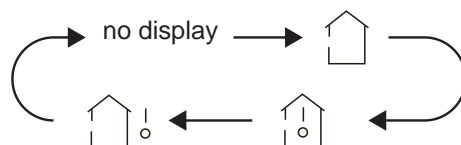
By pressing this button, you can see indoor set temperature, indoor ambient temperature or outdoor ambient temperature on indoor unit's display. The setting on remote controller is selected circularly as below:



OPERATION OF WIRELESS REMOTE CONTROLLER

- When selecting " " or no display with remote controller, temperature indicator on indoor unit displays set temperature.
- When selecting " " with remote controller, temperature indicator on indoor unit displays indoor ambient temperature.
- When selecting " " with remote controller, temperature indicator on indoor unit displays outdoor ambient temperature.

Note:

- Outdoor temperature display is not available for some models. At that time, indoor unit receives " " signal, while it displays indoor set temperature.
- It's defaulted to display set temperature when turning on the unit. There is no display in the remote controller.
- Only for the models whose indoor unit has dual-8 display.
- When selecting displaying of indoor or outdoor ambient temperature, indoor temperature indicator displays corresponding temperature and automatically turn to display set temperature after three or five seconds.

9 WiFi button

When WiFi function is turned on, " WiFi " icon will be displayed on the remote controller; when WiFi function is turned off, " WiFi " icon will disappear.



How to turn on WiFi: Press " WiFi " button to turn on WiFi function.

How to turn off WiFi: Hold " WiFi " button for 5s to turn off WiFi function.



Under off status, press "MODE" and " WiFi " buttons simultaneously for 1s, WiFi module will restore factory settings.

- This function is only available for some models.

10 LIGHT button

Press this button to turn off display light on indoor unit. " " icon on remote controller disappears. Press this button again to turn on display light. " " icon is displayed.

11 CLOCK button

Press this button to set clock time. " " icon on remote controller will blink. Press "▲" or "▼" button within 5s to set clock time. Each pressing of "▲" or "▼" button, clock time will increase or decrease 1 minute. If hold "▲" or "▼" button, 2s later, time will change quickly. Release this button when reaching your required time. Press "CLOCK" button to confirm the time. " " icon stops blinking.

Note:

- Clock time adopts 24-hour mode.
- The interval between two operations can't exceeds 5s. Otherwise, remote controller will quit setting status. Operation for TIMER ON/TIMER OFF is the same.

12 TIMER ON / TIMER OFF button



OPERATION OF WIRELESS REMOTE CONTROLLER

- **TIMER ON button**
"TIMER ON" button can set the time for timer on. After pressing this button, "🕒" icon disappears and the word "ON" on remote controller blinks. Press "▲" or "▼" button to adjust TIMER ON setting. After each pressing "▲" or "▼" button, TIMER ON setting will increase or decrease 1min. Hold "▲" or "▼" button, 2s later, the time will change quickly until reaching your required time. Press "TIMER ON" to confirm it. The word "ON" will stop blinking. "🕒" icon resumes displaying. Cancel TIMER ON: Under the condition that TIMER ON is started up, press "TIMER ON" button to cancel it.
- **TIMER OFF button**
"TIMER OFF" button can set the time for timer off. After pressing this button, "🕒" icon disappears and the word "OFF" on remote controller blinks. Press "▲" or "▼" button to adjust TIMER OFF setting. After each pressing "▲" or "▼" button, TIMER OFF setting will increase or decrease 1min. Hold "▲" or "▼" button, 2s later, the time will change quickly until reaching your required time. Press "TIMER OFF" word "OFF" will stop blinking. "🕒" icon resumes displaying. Cancel TIMER OFF. Under the condition that TIMER OFF is started up, press "TIMER OFF" button to cancel it.

Note:

- Under on and off status, you can set TIMER OFF or TIMER ON simultaneously.
- Before setting TIMER ON or TIMER OFF, please adjust the clock time.
- After starting up TIMER ON or TIMER OFF, set the constant circulating valid. After that, air conditioner will be turned on or turned off according to setting time. ON/OFF button has no effect on setting. If you don't need this function, please use remote controller to cancel it.

Function introduction for combination buttons

Energy-saving function

Under cooling mode, press "TEMP" and "CLOCK" buttons simultaneously to start up or turn off energy-saving function. When energy-saving function is started up, "SE" will be shown on remote controller, and air conditioner will adjust the set temperature automatically according to ex-factory setting to reach to the best energy-saving effect. Press "TEMP" and "CLOCK" buttons simultaneously again to exit energy-saving function.

Note:

- Under energy-saving function, fan speed is defaulted at auto speed and it can't be adjusted.
- Under energy-saving function, set temperature can't be adjusted. Press "TURBO" button and the remote controller won't send signal.
- Sleep function and energy-saving function can't operate at the same time. If energy-saving function has been set under cooling mode, press sleep button will cancel energy-saving function. If sleep function has been set under cooling mode, start up the energy-saving function will cancel sleep function.

OPERATION OF WIRELESS REMOTE CONTROLLER

Auto clean function

Under unit off status, hold "MODE" and "FAN" buttons simultaneously for 5s to turn on or turn off the internal clean function. When the internal clean function is turned on, indoor unit displays "CL". (This function is applicable for some models)

During the self-cleaning process of evaporator, the unit will perform fast cooling or fast heating. There may be some noise, which is the sound of flowing liquid or thermal expansion or cold shrinkage. The air conditioner may blow cool or warm air, which is a normal phenomenon. During cleaning, please make sure the room is well ventilated to avoid affecting the degree of comfort.

Note:

The self-cleaning function can only work under normal ambient temperature. If the room is dusty, clean once a month; if not, clean once every three months. After the self-cleaning function is turned on, you may leave the room. When self-cleaning is finished, the air condition will enter standby mode.

8°C heating function

Under heating mode, press "TEMP" and "CLOCK" buttons simultaneously to start up or turn off 8°C heating function. When this function is started up, "⊕" and "8°C" will be shown on remote controller, and the air conditioner keep the heating status at 8°C. Press "TEMP" and "CLOCK" buttons simultaneously again to exit 8°C heating function.

Note:

- Under 8°C heating function, fan speed is defaulted at auto speed and it can't be adjusted.
- Under 8°C heating function, set temperature can't be adjusted. Press "TURBO" button and the remote controller won't send signal.
- Sleep function and 8°C heating function can't operate at the same time. If 8°C heating function has been set under heating mode, press sleep button will cancel 8°C heating function. If sleep function has been set under heating mode, start up the 8°C heating function will cancel sleep function.
- Under °F temperature display, the remote controller will display 46 °F heating.

Child lock function

Press "▲" and "▼" simultaneously to turn on or turn off child lock function. When child lock function is on, "🔒" icon is displayed on remote controller. If you operate the remote controller, the "🔒" icon will blink three times without sending signal to the unit.

Temperature display switchover function

Under OFF status, press "▼" and "MODE" buttons simultaneously to switch temperature display between °C and °F.

I FEEL Function

Press "▲" and "MODE" buttons simultaneously to start I FEEL function and "🌡️" will be displayed on the remote controller. After this function is set, the remote controller will send the detected ambient temperature to the controller and the unit

OPERATION OF WIRELESS REMOTE CONTROLLER

will automatically adjust the indoor temperature according to the detected temperature. Press this two buttons simultaneously again to close I FEEL function and "⦿" will disappear.

- Please put the remote controller near user when this function is set. Do not put the remote controller near the object of high temperature or low temperature in order to avoid detecting inaccurate ambient temperature. When I FEEL function is turned on, the remote controller should be put within the area where indoor unit can receive the signal sent by the remote controller.

CHANGING BATTERIES AND ADDITIONAL NOTES

To change batteries, slide cover off battery compartment on back of remote controller. Remove and safely discard old batteries. Insert two new AAA 1.5V dry batteries, using correct polarity. Reattach back cover.

NOTE:

- If the remote controller will not be used for a long time, remove batteries to prevent leakage damage.
- Be sure to aim the remote controller at the receiver of the main unit when operating.
- When remote emits a signal, icon will flicker; a tone will be heard when unit receives that signal.

CHANGING BATTERIES

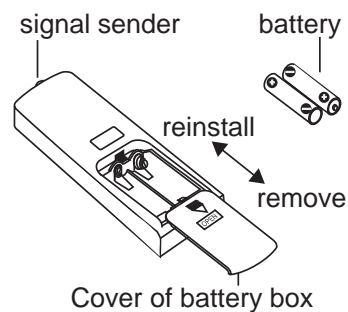

DAMAGED OR LOST REMOTE CONTROLLER

If remote controller is lost or damaged, the Livv system can be turned off directly from the indoor unit. Lift the front panel of the indoor wall unit, then press the AUX button to turn on or turn off. When the unit is on, it will operate in AUTO Mode.

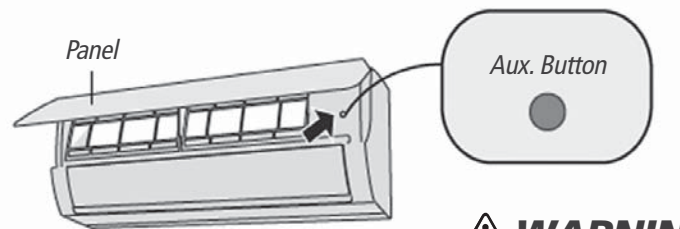

⚠ WARNING

Use insulated object to press the Aux. button.

CARE AND CLEANING

WARNING

Take notice of the following items before cleaning your Livv indoor wall unit.

- To avoid electric shock or injury, do not attempt to clean the unit unless it has been turned off and the indoor and outdoor units have been disconnected from the main power supply.
- Do not wash the unit with water; this may cause an electric shock.
- During cleaning, be sure to use a stable and safe standing platform.

FRONT PANEL CLEANING

Wash the front panel using warm water and mild detergent with a soft cloth or soft brush.

NOTE: Do not use bleach, abrasives or water above 110°F (45°C) as it may cause discoloration or damage to the surface of the unit.

AIR FILTER CLEANING

Changing your air filter on a regular basis prevents many problems. Dirty air filters will affect the performance and the longevity of your unit. It is recommended that air filters be cleaned every three (3) months.

To access and clean the filter:

1. Open Front Panel

Firmly grasp both sides of the front panel and pull upward to about 60 degree angle. (NOTE: do not force panel open).



2. Remove Filter

Remove the filter as indicated in the figure at right.

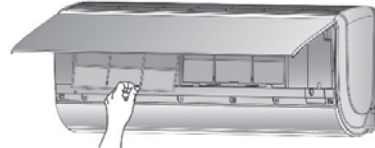

3. Clean Filter

Use vacuum to clean the filter.

When the filter is very dirty, use warm water (below 110°F) to clean it, and then dry filter before replacing.

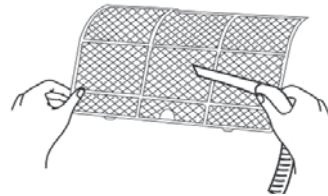

4. Reinstall Filter

Reinstall the filter and then close the panel cover tightly.

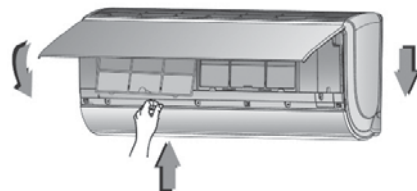

TROUBLESHOOTING

PROBLEM	CAUSE/SOLUTION
System does not restart.	<p>Cause: The system has a built-in three-minute delay to prevent short and/or rapid cycling of the compressor.</p> <p>Solution: Wait three minutes for the protection delay to expire.</p>
Indoor unit emits unpleasant odor when started.	<p>Cause: Typically unpleasant odors are the result of mold or mildew forming on the coil surfaces or the air filter.</p> <p>Solution: Wash indoor air filter in warm water with mild cleaner. If odors persist, contact a qualified service professional to clean the coil surfaces.</p>
You hear a "water flowing" sound.	<p>Cause: It is normal for the system to make "water flowing" or "gurgling" sounds from refrigerant pressures equalizing when the compressor starts and stops.</p> <p>Solution: The noises should discontinue as the refrigerant system equalizes after two or three minutes.</p>
A thin fog or vapor coming out of the indoor unit when system is running.	<p>Cause: It is normal for the system to emit a slight fog or water vapor when cooling extremely humid warm air.</p> <p>Solution: The fog or water vapor will disappear as the system cools and dehumidifies the room space.</p>
You hear a slight cracking sound when the system stops or starts.	<p>Cause: It is normal for the system to make "slight cracking" sounds from parts expanding and contracting during system starts and stops.</p> <p>Solution: The noises will discontinue as temperature equalizes after 2 or 3 minutes.</p>
The system will not run.	<p>Cause: There are a number of situations that will prevent the system from running.</p> <p>Solution: Check for the following:</p> <ul style="list-style-type: none"> • Circuit breaker is "tripped" or "turned off." • Power button of remote is not turned on. • Batteries in the remote controller are low. • Remote controller is in sleep mode or timer mode. • Otherwise, contact a qualified service professional for assistance.
The unit is not heating or cooling adequately.	<p>Cause: There are a number of reasons for inadequate cooling or heating.</p> <p>Solution: Check the following:</p> <ul style="list-style-type: none"> • Remove obstructions blocking airflow into the room. • Clean dirty or blocked air filter that is restricting airflow into the system. • Seal around door or windows to prevent air infiltration into the room. • Relocate or remove heat sources from the room.
Water leakage from the outdoor unit.	<p>Cause: It is normal for the outdoor unit to generate condensate water in the reverse cycle heating and defrost mode.</p> <p>Solution: This is normal. No action is required.</p>

TROUBLESHOOTING

PROBLEM	CAUSE/SOLUTION
Water leaking from the indoor unit into the room.	<p>Cause: While it is normal for the system to generate condensate water in cooling mode, it is designed to drain this water via a condensate drain system to a safe location.</p> <p>Solution: If water is leaking into the room, it may indicate one of the following.</p> <ul style="list-style-type: none">• The indoor unit is not level right to left. Level indoor unit.• The condensate drain pipe is restricted or plugged. All restrictions must be removed to allow continuous drainage by gravity.• If problem persists, contact a qualified service professional for assistance.
Wireless remote controller does not work.	<p>Cause: There are a number of possible reasons.</p> <p>Solution: Check the following:</p> <ul style="list-style-type: none">• The batteries might be low. Change the batteries.• The remote controller must be within 25 ft. (7.5 m) with no obstructions of the indoor unit. If remote controller needs to be replaced, contact a qualified service professional for assistance. In the meantime, use the Aux Button to operate the system.
The unit will not deliver air.	<p>Cause: There are a number of system functions that will prevent air flow.</p> <p>Solution: Check for the following:</p> <ul style="list-style-type: none">• In heating mode, the indoor fan may not start for three minutes if the room temperature is very low. This is to prevent blowing cold air.• In heat mode, if the outdoor temperature is low and humidity is high, the system may need to defrost for up to 10 minutes before beginning a heating cycle.• In dry mode, the indoor fan may stop for up to three minutes during the compressor off delay.• Otherwise, you should contact a qualified service professional for assistance.
Moisture or condensation on the discharge air louvers or outlet vents.	<p>Cause: It is normal for the system to develop condensation or moisture on the discharge air louvers when cooling warm humid air for a long period of time.</p> <p>Solution: The condensation or moisture will disappear as the system cools and dehumidifies the room space.</p>

CAUTION

Stop operation and call for service in the following circumstances:

- You hear a harsh or unusual sound during operation.
- Unusually foul odor is emitted during operation.
- Water is leaking in the room.
- You notice a burning smell or see smoke.
- Circuit breaker trips frequently, or unit stops abnormally often.

ENERGY SAVING TIPS

- 1. Reduce room setpoint at night:** During the nighttime hours you don't require the same level of conscious cooling or heating. Try using Sleep Mode to gradually relax room temperature and allow the unit to run less and save energy.
- 2. Curtains and shades:** In the summer, it is recommended to block the effects of the sun. Close window curtains and shades on the south and west side of your home to help block solar heat. In winter, the sun is your friend. Open curtains and shades to allow solar heat into your room.
- 3. Close doors:** If you don't need to heat and cool your whole home, confine the heating and cooling to one room by closing doors.
- 4. Service the unit:** Some basic maintenance might be all you need. The outdoor unit will greatly benefit from a good hosing off, especially in treed areas where seeds and other debris can stick to coil fins and make the unit work up to 15% harder!
- 5. Rearrange the room:** Furniture that obstructs airflow means you could be heating and cooling the back of a chair instead of the actual living space. Remove or rearrange obstacles blocking airflow.
- 6. Try 75 degrees:** 75°F is a good point for an air conditioner to run at its optimal performance level. Even a 5-degree change in temperature can make your unit use up to 40% more energy.
- 7. Lighting:** Turning lights off can help reduce your heat. Each light bulb is a tiny heater. Your air conditioner must waste energy overcoming the heat from your lights to reach and hold your desired room temperature.
- 8. Is anyone home?** If possible, while you're away turn your unit to Auto mode and make sure windows and curtains are closed. Although room temperature may be less than optimal for a few minutes when you return, the unit will soon have the room back to your desired temperature.
- 9. Don't forget the fan:** The fan is much like a car. The faster it runs, the more energy it uses. Sometimes we need the car to go fast, but slow is good enough most of the time. Try saving money by using the comfortable quiet low fan speed as much as possible.



LIMITED WARRANTY STATEMENT

FOR WARRANTY SERVICE OR REPAIR:

Contact your installing contractor. You may find the installer's name on the equipment or in your Owner's packet. Complete product registration below and send back by email to Service@twclimate.com.

PRODUCT REGISTRATION

Model No. _____

Serial No. _____ Date of Installation _____

Owner Name _____

Address of Installation _____

Installing Contractor _____

Address _____

Phone No. / E-mail _____

GREE distributor (hereinafter "Company") warrants this product against failure due to defect in materials or workmanship under normal use and maintenance as follows. All warranty periods begin on the date of original installation. If the date cannot be verified, the warranty period begins one hundred twenty (120) days from date of manufacture. If a part fails due to defect during the applicable warranty period, Company will provide a new or remanufactured part, at Company's option, to replace the failed defective part at no charge for the part. This limited warranty is subject to all provisions, conditions, limitations and exclusions listed below.

- A warranty period of Five (5) years on all parts to the original registered end user.
- A warranty period of 90 days on the remote control provided with the original unit.
- Limited warranty applies only to systems that are properly installed by a state certified or licensed HVAC contractor, under applicable local and state law in accordance with all applicable building codes and permits; GREE installation and operation instructions and good trade practices.
- Warranty applies only to products remaining in their original installation location.
- Defective parts must be returned to the distributor through a registered servicing dealer for credit.

LIMITATIONS OF WARRANTIES: ALL IMPLIED WARRANTIES AND/OR CONDITIONS (INCLUDING IMPLIED WARRANTIES OR CONDITIONS OF MERCHANTABILITY AND FITNESS FOR A PARTICULAR USE OR PURPOSE) ARE LIMITED TO THE DURATION OF THIS LIMITED WARRANTY, SOME STATES OR PROVINCES DO NOT ALLOW LIMITATIONS ON HOW LONG AN IMPLIED WARRANTY OR CONDITION LASTS, SO THE ABOVE MAY NOT APPLY TO YOU. THE EXPRESS WARRANTIES MADE IN THIS WARRANTY ARE EXCLUSIVE AND MAY NOT BE ALTERED, ENLARGED, OR CHANGED BY ANY DISTRIBUTOR, DEALER, OR OTHER PERSON, WHATSOEVER.

THIS WARRANTY DOES NOT COVER:

1. Labor or other costs incurred for diagnosing, repairing, removing, installing, shipping, servicing or handling of either defective parts, or replacement parts, or new units.
2. Product cleaning required prior to warranty service and repair.
3. Normal maintenance as outlined in the installation and servicing instructions or Owner's Manual, including filter cleaning and/or replacement and lubrication.
4. Failure, damage or repairs due to faulty installation, misapplication, abuse, improper servicing, unauthorized alteration or improper operation.
5. Failure to start due to voltage conditions, blown fuses, open circuit breakers, or damages due to the inadequacy or interruption of electrical service.
6. Failure or damage due to floods, winds, fires, lightning, accidents, corrosive environments (rust, etc.) or other conditions beyond the control of the Company.
7. Failure or damage of coils or piping due to corrosion on installations within one (1) miles of sea coast or corrosive body.
8. Parts not supplied or designated by Company, or damages resulting from their use.
9. Products installed outside the 48 contiguous United States, except the District of Columbia and Hawaii.
10. Electricity or fuel costs, or increases in electricity or fuel costs from any reason whatsoever, including additional or unusual use of supplemental electric heat.
11. Any cost to replace, refill or dispose of refrigerant, including the cost of refrigerant.
12. Shipping damage or damage as a result of transporting the unit.
13. Accessories such as condensate pumps, line sets and so forth are not covered.
14. Any special, indirect or consequential property or commercial damage of any nature whatsoever. Some states or provinces do not allow the exclusion of incidental or consequential damages, so the above limitation may not apply to you.
15. Consumable components, such as air filters, are not covered under parts warranty.

This warranty gives you specific legal rights, and you may also have other rights which vary from state to state. In jurisdictions where warranty benefits conditioned on registration are prohibited by law, registration is not required, and the STANDARD warranty period shown above will apply.

WSO02012020 DLSWARR-HP

